



INSTALLATION, OPERATION & MAINTENANCE FOR SVF SERIES D8/T7 BALL VALVES



GENERAL

SVF Ball valves have been designed and engineered to provide long lasting and trouble free service when used in accordance with the instructions and specifications herein.

The following instructions refer only to SVF Series "D8/T7 Ball Valves.

Keep protective cover in place until moment of installation. Valve performance depends upon preventing damage to ball surface. Upon removal of cover, make sure that the valve is completely open and free of obstruction.

If requested, valves can be shipped from the factory containing a silicon based lubricant which aids in the assembly of the valve. This may be removed with a solvent if found intolerable.

Certain ferrous valves are phosphate and oil dipped during the course of manufacture, but they are completely non-toxic and the valves are quite safe to use for edible or potable products.

STORAGE:

All manual valves are shipped in the fully open position with protective end caps (covers). Keep all protective packaging, flange covers, or end caps attached to the valves during storage. To avoid damage to the seat due to contact with the balls edge, leave the valve in the **fully open or closed position** during storage. It is recommended to keep the valves in a clean and dry environment until ready for use.

!!!CAUTION! Safety Precautions!!!

Before removing valve from pipeline NOTE that:

Media flowing through a valve may be corrosive, toxic, flammable, a contaminant or harmful nature. Where there is evidence of harmful fluids having flowed through the valve, the utmost care must be taken. It is suggested that the following minimal safety precautions be taken when handling valves.

1. Always wear eye shields.
2. Always wear gloves and overalls.
3. Wear protective footwear.
4. Wear protective headgear.
5. Ensure that running water is readily accessible.
6. Have a suitable fire extinguisher ready if media is flammable.
7. Be sure that you are aware of the fluid that has been passing through the valve before opening or dismantling any valve. Require MSDS information.

By checking line gauges ensure that no pressure is present at the valve.

Ensure that any media is released by operating valve slowly to half open position. Ideally, the valve should be decontaminated when the ball is in the half open position.

These valves, when installed, have body connectors which form an integral part of the pipeline and the valve cannot be removed from the pipeline without being dismantled.

Valves and accessories must not be used as a sole support of piping or human weight. Safety accessories such as safety relief (overpressure) valves are the responsibility of the system designer.

It is the user/system designer's responsibility to use insulation in high temperature applications. Refer to OSHA documents for more details.

What do you need today?™

HIGH PURITY
CleanFLOW®

PRO-SPEC
PROCESS SPECIFIC
WWW.PRO-SPEC.NET

QUALITY FLOWS
THROUGH US

Please visit www.SVF.net for the latest updates on this document. All data posted on our website supersede all prior publications • [Document # SVF_Series_D8/T7_IOM - 10/09/2015]

www.SVF.net

SVF Flow Controls, Inc. • 13560 Larwin Circle • Santa Fe Springs, CA 90670 • Tel: 1.800.783.7836 • FAX: 562.802.3114
Sales@SVF.net • Visit our website: www.SVF.net • © SVF Flow Controls, Inc. • Specifications subject to change without notice



INSTALLATION, OPERATION & MAINTENANCE FOR SVF SERIES D8/T7 BALL VALVES

INSTALLATION

The valve may be installed for flow or vacuum in either direction. Carefully exclude pipe sealants from the valve cavity. When installing, use standard gaskets suitable for the specific service. Tighten flange bolts or studs evenly.

OPERATION

SVF Series D8/T7 valves provide tight shut off to the non-flow port when used under normal conditions and in accordance with SVF's published pressure/temperature chart. If these valves are used in a partially open (throttled) position seat life may be reduced.

SVF Series D8/T7 valves have quarter-turn or half-turn operation in a clockwise or counterclockwise direction. It is possible to determine the flow path by the position of the wrench handle.

Any media which might solidify, crystallize or polymerize should not be allowed to stand in the ball valve cavities unless regular maintenance is provided. If minimal maintenance is required, SVF offers steam jacketed ball valves.

TORQUE REQUIREMENTS

Torque ratings are subject to variations depending on the length of time between cycles and the media in the system.

Breakaway torque is that force which must be exerted to cause the ball to begin to open. Operating torque requirements will vary depending on the length of time between cycles, media in the system, line pressure and type of valve seat.

MAINTENANCE

With self-wiping ball/seats, SVF valves have a long, trouble free life, and maintenance is seldom required. When necessary, valves may be refurbished, using a small number of components, none of which require machining.

SVF valves are designed for easy service and assembly in the field. The following checks will help to extend valve life, or reduce plant problems.

SVF ball valves utilize live-loaded stem seals featuring Belleville washers (disk springs) that maintain constant pressure on the Stem Seal area even under a wide range of pressure and temperature fluctuations. If stem leakage is evident proceed as follows:

STEM LEAKAGE

Examine the disk springs (Belleville washers) for damage. If in good condition tighten the gland nut until disk springs are firmly compressed, then back nut off 1/16th of a turn. If damaged, dismantle the stem down to the gland, fit new disk springs with their outer edges touching, replace and retighten using gland nut. Further maintenance necessitates dismantling of the valve.

LEAKAGE AT BODY JOINT

Check for tightness at the body connector bolts. If loose, tighten body bolts. Excessive force will damage the bolts. (See Table A below) If there is still leakage it will be necessary to dismantle the valve and replace the body seals.

IN-LINE LEAKAGE

Check that the valve is fully closed. If leakage occurs while the valve is in the closed position, a seat or ball sealant surface may be damaged and it will be necessary to disassemble the valve.

NOTE: If stem leakage and leakage at the body joint are not cured by simple means described above, it will be necessary to dismantle the valve. If there is no stem leakage the stem assembly should not be touched.

WELDING OF SERIES "D8/T7" VALVES WITH ALL BODY SEALS (EXCEPT BUNA "N"/RUBBER):

1. Place valve in the OPEN position.
2. Align the valve between the pipe ends and make the appropriate welds according to standard welding procedures. **NOTE: The body temperature in the seal area must not exceed 392°F.**
3. Allow the valve to cool.
4. Tighten the body bolts according to the torque values (Page 4, Table A).



INSTALLATION, OPERATION & MAINTENANCE FOR SVF SERIES D8/T7 BALL VALVES

REBUILDING

Before rebuilding, check that all the correct components are available and that they are fit for reassembly. When rebuilding, cleanliness is essential to allow long valve life and provide cost effective maintenance. CAUTION: NO BODY OR STEM SEALS ARE REUSABLE. Care must be taken to avoid scratching the seats and seals during installation.

NOTE: Caution must be taken with valves that have been in hazardous media. They must be decontaminated before disassembly by relieving the line pressure and flushing the line with the valve in the partially open position. Protective clothing, face shields, gloves, etc., MUST BE USED for this operation.

A **DISASSEMBLY OF VALVE** (Removed from line)

- 1.) Remove the End Connectors (#2) by removing the Body Bolts (#16 & 16A) and Body Bolt Nuts (#15).
- 2.) Once the End Connectors (#2) have been separated from the Body (#1), remove the Body Seals (#6 & 6A) and Seats (#5 or 5A).
- 3.) Make sure the Ball (#3) is in the closed position, (the flat sides of the Stem (#4) must be parallel to the body seal grooves of the body), the Ball (#3) can be taken out easily from the Body (#1).

B **REMOVING STEM ASSEMBLY 1/4" ~ 2"**

- 1.) Remove Handle (#12) by removing Handle Nut (#14) along with the Lock Washer (#13).
- 2.) Remove the Tab Lock (#11), Stem Nut (#10), Belleville Washers (#9), Gland (#8), and Stem Seals (#7).
- 3.) Push the Stem (#4) down into the body cavity to remove. Once removed take off the Thrust Washer (#18).

C **INSPECTION**

- 1.) The ball and the surfaces of the seats should be free of pit marks and scratches. Light marring from the action of the ball against the seats is normal and will not affect the operation of the valve.
- 2.) The stem and body surfaces, which the thrust and washer make contact with, should be free of pit marks and scratches.

D **REASSEMBLY**

- 1.) Apply an adequate amount of lubricant compatible with the media being handled around the Ball (#3), Seats (#5 or 5A), Body Seals (#6 & 6A), Stem (#4), and Thrust Washer (#18).
- 2.) For stem reassembly, disassembly procedure should be followed in reverse order.
- 3.) When stem assembly is complete, tighten Stem Nut (#10) according to the values in Table A.
- 4.) With the Stem (#4) in the closed position (the flat sides of the Stem (#4) must be parallel to the body seal grooves of the body), insert the respective 3-way "S1" or "S2" Ball (#3 or 3A) into Body (#1) so that the Ball's stem slot engages with the tang at the base of the Stem (#4), as shown in Figure 1, Page 4. NOTE: Make sure the 3-way Ball is PROPERLY CONFIGURED to the proper flow pattern. (Refer to Ball Configurations on page 6.
- 5.) By holding the Ball (#3 or 3A) in the body cavity, insert the Body Seals (#6) making sure they rest squarely on the center seal surface of the Body (#1).
- 6.) Insert Seats (#5 or 5A) into the Body (#1). Make sure they seat firmly on back surface of each recess.
- 7.) Merge the End Connectors (#2) with the Body (#1).
- 8.) Insert the Body Bolts (#16 & 16A) and tighten with nuts (#15) diagonally, in accordance to the cross pattern procedure shown on page 4 for sizes 1/4" to 2".
- 9.) In the final assembly step, ensure that the Body Bolts (#16 & 16A) are tightened according to torque values in Table A.
- 10.) VERY IMPORTANT NOTE!
Make sure the 3-way Ball is PROPERLY CONFIGURED to the proper flow pattern before doing the final installation of the valve. Refer to the Ball Configuration on Page 6.

INSTALLATION, OPERATION & MAINTENANCE FOR SVF SERIES D8/T7 BALL VALVES

TORQUE SPECS

Certain precautions need to be followed when tightening bolts down to their corresponding torques to help prevent bolt galling. There are two passes each bolt has to undergo during the process, first pass and the final pass. Once every bolt has met the first pass requirement, the final pass can be initiated. When tightening down bolts it is necessary to follow the corresponding bolt pattern shown below.

TABLE A: TORQUE REQUIREMENTS (in-lbs)

Valve Size	Bolt Pattern	Body Bolts				Stem Nuts
		Stainless Steel First Pass	Stainless Steel Final Pass	Carbon Steel First Pass	Carbon Steel Final Pass	
1/4"	4	48	80	53	88	35
3/8"	4	48	80	53	88	35
1/2"	4	48	80	53	88	35
3/4"	4	48	80	53	88	35
1"	4	101	168	117	195	80
1-1/2"	4	207	345	240	400	115
2"	4	207	345	240	400	115

BOLT TIGHTENING SEQUENCE

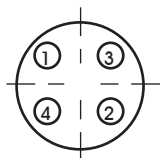

4 Bolt Pattern

TABLE C

D8/T7	BD8/BT7
1/4"	-
3/8"	-
1/2"	-
3/4"	1/2"
1"	3/4"
1-1/2"	1-1/4"
2"	1-1/2"

NOTE: When ordering parts, keep in mind that Series D8/T7 Standard Port valves and the Series BD8/BT7 Full Port valves use interchangeable parts. Refer to Table C to see the valve size comparison.

REPAIR KITS

Repair Kits are available from SVF Flow Controls, Inc. Table B below shows what the kits consist of. When ordering a Repair Kit, please be sure to specify the type, size and seating material of the valve.

When repairing a valve use only SVF Flow Controls, Inc. authorized spare parts including; bolts and nuts, etc. In addition to maintenance kits, spare parts are available from SVF Flow Controls, Inc. They are: balls, stems and glands. If additional parts are required (body and ends) it is normally recommended that the complete valve be replaced.

Components from a different valve series should not be used with the repair of any other valve. If the valve is altered in any way, no liability can be accepted by SVF Flow Controls, Inc.

TABLE B: GENERAL REPAIR KIT - 1/4" ~ 2"

Part	Quantity	
	Series D8	Series T7
Thrust Washers	1	1
Stem Seals	2	2
Belleville Washers	2	2
Seats	2	2
Body Seals	3	1

FIGURE 1

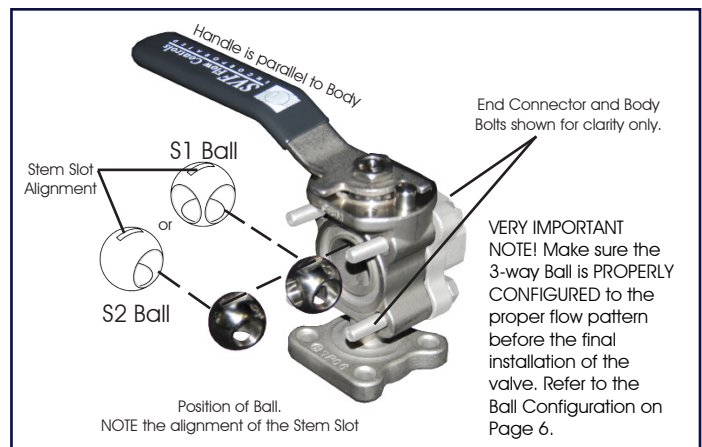



MATERIALS OF CONSTRUCTION FOR SVF SERIES D8/T7 BALL VALVES - Sizes 1/4" ~ 2"

Item #	Part Name	Materials	Recommended Spare	Wetted
1	Body	316 Stainless Steel ASTM A351-CF8M, Carbon Steel ASTM A216 WCB	-	X
2	End Connector	316 Stainless Steel ASTM A351-CF8M, Carbon Steel ASTM A216 WCB	-	X
3	Ball (S1 = 90°)	316 Stainless Steel ASTM A351-CF8M	-	X
3A	Ball (S2 = 180°)	316 Stainless Steel ASTM A351-CF8M	-	X
4	Stem	316 Stainless Steel ASTM A276	-	X
5	Seat - D8 Series	SupraLon™, TFM1600™, Delrin®, UHMWPE, PEEK	X	X
5A	Seat - T7 Series	NRG, PTFE	X	X
6	Body Seal - D8 Series	PTFE, Buna "N", GRAFOIL®, UHMWPE, SupraLon™	X	X
6A	Body Seal - T7 Series	PTFE, GRAFOIL®, SupraLon™	X	X
7	Stem Seal	SupraLon™, UHMWPE	X	X
8	Gland	316 Stainless Steel	-	-
9	Belleville Washers	316 Stainless Steel	X	-
10	Stem Nut	316 Stainless Steel	-	-
11	Tab Lock	316 Stainless Steel	-	-
12	Handle	316 Stainless Steel	-	-
13	Lock Washer	316 Stainless Steel	-	-
14	Handle Nut	316 Stainless Steel	-	-
15	Body Bolt Nut	316 Stainless Steel	-	-
16	Body Bolt	316 Stainless Steel	-	-
16A	Body Bolt (Bottom Port)	316 Stainless Steel	-	-
18	Thrust Washer	SupraLon™, PEEK, Delrin®	X	X
19	Stop Pin	304 Stainless Steel	-	-
20	Stop Plate (S2 Only)	300 Series Stainless Steel	-	-

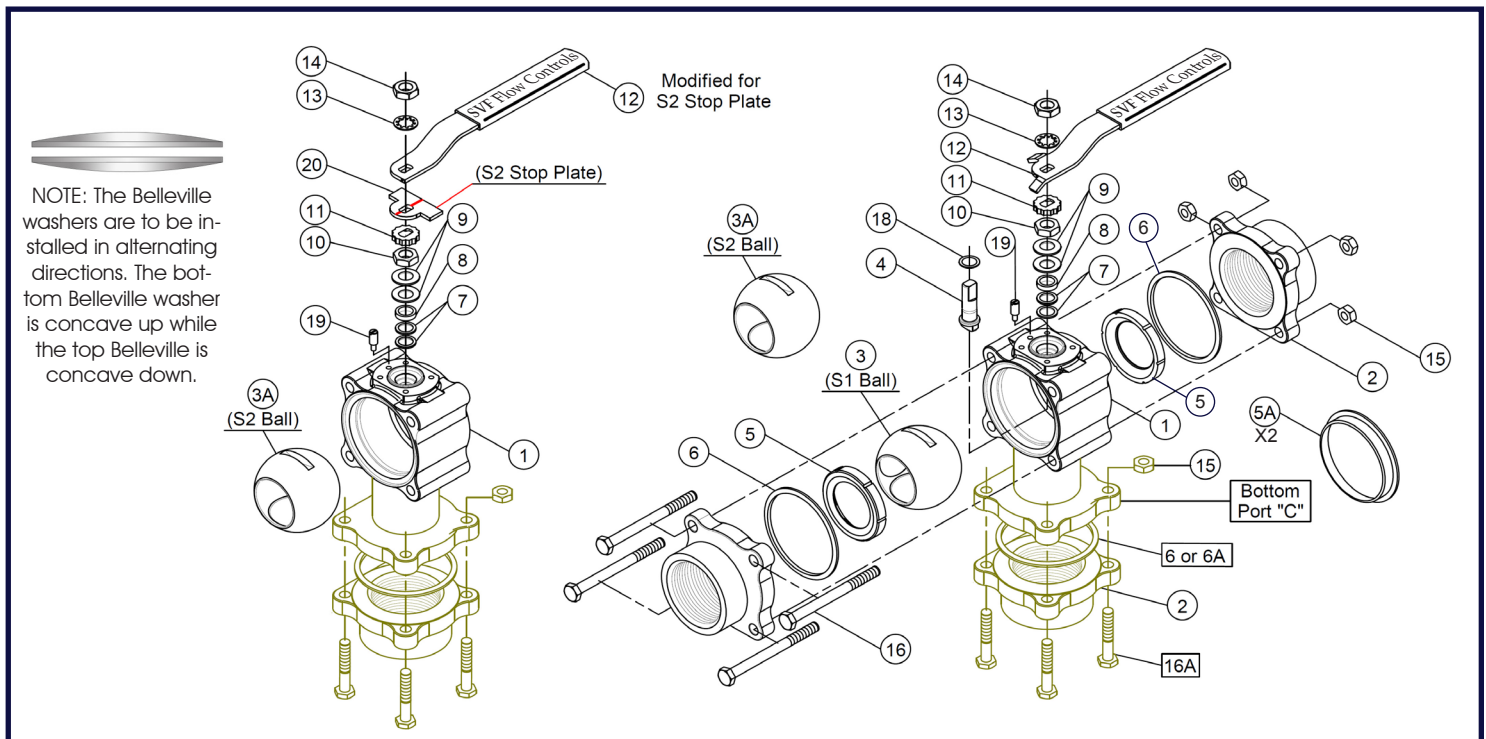

D8 DIVERTER VALVE FLOW PATHS

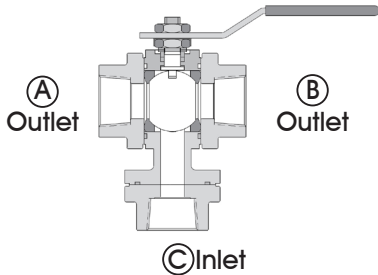

The **D8 Diverter Valve** consists of a two-piece seat and body seal with the inlet at Port C.

Flow Paths are:

- Inlet Port **C** to Outlet Port **A**
- Inlet Port **C** to Outlet Port **B**

T7 THREE-WAY VALVE FLOW PATHS

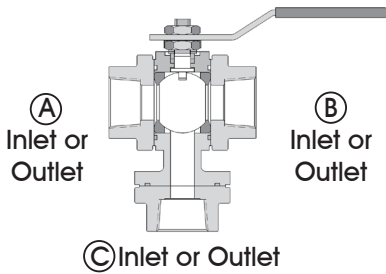

The **T7 Three-Way Valve** consists of a one-piece seat and body seal, allowing the inlet to be at any one of the ports A, B, or C.

Flow Paths are:

- Inlet Port **C** to Outlet Port **A**
- Inlet Port **C** to Outlet Port **B**
- Inlet Port **A** to Outlet Port **C**
- Inlet Port **B** to Outlet Port **C**

OPERATION

The D8 Diverter Valve or T7 Three-Way Valve can be supplied with either 90° operation (S1 ball) or 180° operation (S2 ball).

S1 (90° Operation)

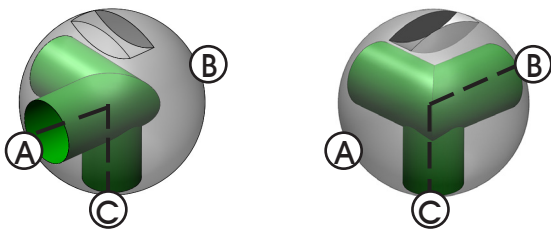

Ports C and A
Open (0°)

Ports C and B
Open (90°)

For S1 (90° Operation), the Stop Plate is an integral part of the handle.

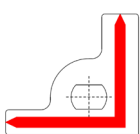

NOTE: It is normal that media will flow from Port "C" to both Ports "A" & "B" while the ball is being rotated from one flow path to the other.

Contact SVF for additional flow paths

S2 (180° Operation)

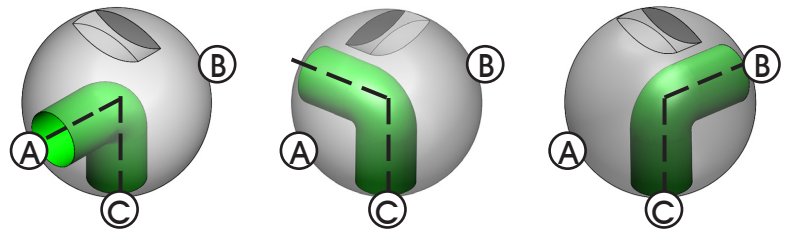

Ports C and A
Open (0°)

Ports A and B
Closed (90°)

Ports C and B
Open (180°)

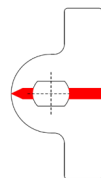

For S2 (180° Operation), the Stop Plate is a separate part (Refer to #20 on the Materials of Construction).

NOTE: Media flow will not occur when the handle is in-line (parallel) with the body of the valve. This is the CLOSED/SHUT-OFF position (Refer to Figure 1, Page 4).